



# Operation **Manual**

**XG25-40KTR**

**Photovoltaic Grid-connected Inverter**



## **Preface**

The manual is intended to provide detailed information of product information, installation, application, trouble shooting, precautions and maintenance of iMars series grid-tied solar inverters. The manual does not contain all the information of the solar system. Please read this manual carefully and follow all safety precautions seriously before any moving, installation, operation and maintenance to ensure correct use and high performance of operation on the inverter.

The use of the iMars series grid-tied solar inverters must comply with local laws and regulations on grid-tied power generation.

The manual needs to be kept well and be available at all times.

All rights reserved. The contents in this document are subject to change without notice.

There may be data deviation because of product improving. Detailed information is in accordant with the final product.

# Content

|   |           |
|---|-----------|
| <b>Preface</b> .....                                  | <b>i</b>  |
| <b>Content</b> .....                                  | <b>ii</b> |
| <b>1 Safety precautions</b> .....                     | <b>1</b>  |
| 1.1 Warning marks.....                                | 1         |
| 1.2 Safety guidance .....                             | 2         |
| 1.2.1 Transport and installation .....                | 3         |
| 1.2.2 Grid-tied operation.....                        | 3         |
| 1.2.3 Maintenance and inspection .....                | 4         |
| 1.2.4 Waste disposal.....                             | 4         |
| <b>2 Product overview</b> .....                       | <b>5</b>  |
| <b>2.1 Grid-tied PV power generation system</b> ..... | <b>5</b>  |
| 2.1.1 Supported grid connection structure .....       | 5         |
| <b>2.2 Product appearance</b> .....                   | <b>6</b>  |
| 2.3 Nameplate .....                                   | 7         |
| 2.4 Product model.....                                | 8         |
| 2.5 Outline dimension and weight.....                 | 9         |
| 2.6 The front panel.....                              | 10        |
| 2.6.1 LED panel (Modern design) .....                 | 10        |
| 2.6.2 LCD panel.....                                  | 11        |
| 2.7 Bottom of chassis .....                           | 11        |
| <b>3 Storage</b> .....                                | <b>12</b> |
| <b>4 Installation</b> .....                           | <b>13</b> |
| 4.2 Preparation before installation .....             | 14        |
| 4.2.1 Installation tool .....                         | 14        |
| 4.2.2 Installation environment.....                   | 15        |

---

|  |           |
|--|-----------|
| 4.3 Space requirements .....                       | 16        |
| 4.4 Dimensions of the mounting bracket.....        | 17        |
| 4.5 Wall installation .....                        | 18        |
| 4.6 Installation of inverter.....                  | 18        |
| <b>5 Electrical connection .....</b>               | <b>20</b> |
| 5.1 Overview of electrical connection.....         | 20        |
| 5.2 Connect the protective earth wire.....         | 20        |
| 5.3 Connection of solar string.....                | 21        |
| 5.4 Three-phase inverter grid connection .....     | 22        |
| 5.4.1 Grid connection.....                         | 23        |
| <b>6 Running .....</b>                             | <b>25</b> |
| 6.2 Inverter grid-tied running.....                | 25        |
| 6.3 Inverter stop .....                            | 26        |
| 6.4 Regular inspection and maintenance.....        | 26        |
| 6.4.1 Regular inspection and maintenance list..... | 26        |
| 6.4.2 Maintenance guidance.....                    | 27        |
| <b>7 LCD display operation .....</b>               | <b>29</b> |
| <b>8 Troubleshooting .....</b>                     | <b>30</b> |
| <b>9 Contact us .....</b>                          | <b>33</b> |
| <b>10 Appendix.....</b>                            | <b>34</b> |

# 1 Safety precautions

iMars series grid-tied solar inverters are designed and tested strictly in accordance with relevant international safety standards. As an electrical and electronic device, all relevant safety regulations must be strictly complied during installation, operation, and maintenance. Incorrect use or misuse may result in:









- Injury to the life and personal safety of the operator or other people.
- Damage to the inverter or other property belonging to the operator or other people.

In order to avoid personal injury, damage to the inverter or other devices, please strictly observe the following safety precautions.







This chapter mainly describes various warning symbols in operation manual and provides safety instructions for the installation, operation, maintenance and use of the iMars series grid-tied solar inverters.

## 1.1 Warning marks

Warning marks inform users of conditions which can cause serious physical injury or death, or damage to the device. They also tell users how to prevent the dangers. The warning marks used in this operation manual are shown below:

| Mark  | Name                    | Instruction  | Abbreviation  |
|---|-------------------------|--|---|
|  Danger    | Danger                  | Serious physical injury or even death may occur if not follow relevant requirements.   |    |
|  Warning | Warning                 | Physical injury or damage to the device may occur if not follow relevant requirements. |  |
|  Forbid  | Electrostatic sensitive | Damage may occur if relevant requirements are not followed.                            |  |
|  Hot     | High temperature        | Do not touch the base of the inverter as it will become hot.                           |  |
| <b>Note</b>   | Note                    | The procedures taken for ensuring proper operation.                                    | <b>Note</b>   |

## 1.2 Safety guidance

|  |   |
|--|---|
|   | <ul style="list-style-type: none"> <li>● After receiving this product, first confirm the product package is intact. If any question, contact the logistic company or local distributor immediately.</li> <li>● The installation and operation of P V inverter must be carried out by professional technicians who have received professional trainings and thoroughly familiar with all the contents in this manual and the safety requirements of the electrical system.</li> <li>● Do not carry out connection/disconnection, unpacking inspection and unit replacement operations on the inverter when power source is applied. Before wiring and inspection, users must confirm the breakers on DC and AC side are disconnected and wait for at least 5 minutes.</li> </ul> |
|   | <ul style="list-style-type: none"> <li>● Ensure there is no strong electromagnetic interference caused by other electronic or electrical devices around the installation site.</li> <li>● Do not refit the inverter unless authorized.</li> <li>● All the electrical installation must conform to local and national electrical standards.</li> </ul>   |
|   | <ul style="list-style-type: none"> <li>● Do not touch the housing of the inverter or the radiator to avoid scald as they may become hot during operation</li> </ul>   |
|   | <ul style="list-style-type: none"> <li>● Ground with proper technics before operation.</li> </ul>   |
|    | <ul style="list-style-type: none"> <li>● Do not open the surface cover of the inverter unless authorized. The electronic components inside the inverter are electrostatic sensitive. Do take proper anti-electrostatic measures during authorized operation.</li> </ul>   |
|   | <ul style="list-style-type: none"> <li>● The inverter must be reliably grounded.</li> </ul>   |
|   | <ul style="list-style-type: none"> <li>● Ensure that DC and AC side circuit breakers have been disconnected and wait at least 5 minutes before wiring and checking.</li> </ul>  |
| <p><b>Note: Technical personnel who can perform installation, wiring, commissioning, maintenance, troubleshooting and replacement of the iMars series grid-tied solar inverters must meet the following requirements:</b></p>  |   |
| <ul style="list-style-type: none"> <li>● Operators need professional training.</li> <li>● Operators must read this manual completely and master the related safety precautions.</li> <li>● Operators need to be familiar with the relevant safety regulations for electrical systems.</li> </ul> |   |

- Operators need to be fully familiar with the composition and operating principle of the entire grid-tied solar power generation system and related standards of the countries/regions in which the project is located.
- Operators must wear personal protective equipment.

### 1.2.1 Transport and installation

|   |   |
|---|---|
|  | <ul style="list-style-type: none"> <li>● During storage or transport, ensure the inverter package and the chassis is intact, dry and clean.</li> <li>● The movement and installation of the inverter require at least two persons due to its heavy weight.</li> <li>● Select proper tools for movement and installation to ensure the inverter can operate normally and avoid physical injury. The installation personnel must take mechanical protective measures such as wearing anti-drop shoes or working clothes to protect physical security.</li> <li>● The inverter must be installed by professional technicians.</li> <li>● Do not store or install the inverter on flammable and combustible objects; keep the inverter away from flammable and combustible objects.</li> <li>● Do not install the inverter in places easily accessible to children or other public.</li> <li>● Remove the metal accessories in hands eg ring or bracelet before device installation and electrical connection to avoid electric shock.</li> <li>● The solar battery component exposed to the sunlight may generate dangerous voltage. Users must cover the battery component with fully-lightproof materials before electrical connection</li> <li>● The inverter input voltage cannot exceed the max input voltage, otherwise the inverter may be damaged.</li> <li>● Grid-tied PV inverter is not applicable to the positive or negative ground system of solar battery component.</li> <li>● Ensure inverter PE is grounded properly, otherwise the inverter cannot run normally.</li> <li>● Ensure the inverter is installed firmly and electrical wiring is reliable.</li> </ul> |
|---|---|

**Note: Grid-tied PV inverter is only suitable for crystalline silicon solar module.**

### 1.2.2 Grid-tied operation

|   |  |
|---|--|
|  | <ul style="list-style-type: none"> <li>● Permissions by local electric power agency must be obtained and the inverter grid-tied power generation operation must be done by professional technicians.</li> <li>● All electrical connections must meet the electrical standards of the countries/regions in which the project is located.</li> </ul> |
|---|--|

|  |  |
|--|--|
|  | <ul style="list-style-type: none"> <li>● Ensure the inverter is installed firmly and electrical wiring is reliable before operating on the inverter.</li> <li>● Do not open the housing of the inverter when the inverter is working or powered up.</li> </ul> |
|--|--|

### 1.2.3 Maintenance and inspection

|   |   |
|---|---|
|  | <ul style="list-style-type: none"> <li>● The maintenance, inspection and repair of the inverter must be done by well trained and qualified professional technicians.</li> <li>● Contact distributors and manufactures for repair of the inverter.</li> <li>● In order to avoid irrelevant personnel from entering the maintenance area during maintenance, temporary warning labels must be placed to warn non-professionals to enter or use fence for isolation.</li> <li>● Before carrying out any maintenance operations, users must disconnect the breaker on grid side, then disconnect the DC breaker and wait for at least 5 minutes until the internal parts of the inverter are fully discharged.</li> <li>● The internal of the inverter are mostly electrostatic-sensitive circuits and parts, users must follow electrostatic protection protocols and take anti-electrostatic measures.</li> <li>● Do not use components provided by other companies when repairing the inverter.</li> <li>● The inverter can be started again for grid-tied power generation only after confirming there is no fault that may impact the safety performance of the inverter.</li> <li>● Do not get close to or touch the grid or any metal conductive parts in the PV power generation system during operation, otherwise electric shock or fire may occur. Take note of any safety marks and instructions similar to "Danger, electric shock risk".</li> </ul> |
|---|---|

### 1.2.4 Waste disposal

|   |  |
|---|--|
|  | <ul style="list-style-type: none"> <li>● Do not dispose of the inverter together with household waste. The user has the responsibility and obligation to send it to the designated organization for recycling and disposal.</li> </ul> |
|---|--|



## 2 Product overview

This chapter mainly describes the appearance, package accessories, nameplate and technical parameters of the grid-tied inverter.

### 2.1 Grid-tied PV power generation system

Grid-tied PV power generation system comprises solar panels, grid-tied inverter, energy meter and power grid.

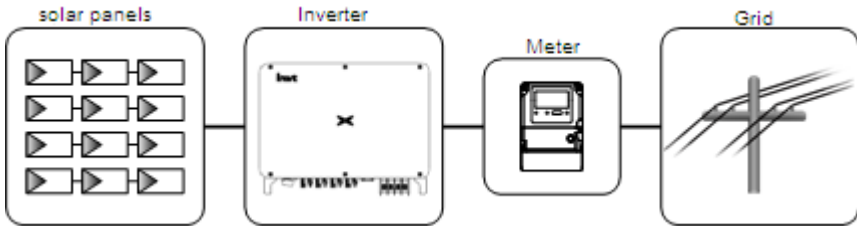

Fig 2.1 Application of grid-tied PV inverter

The grid-tied PV inverter is the core part of solar grid-tied PV power generation system. The sunlight can be converted to DC energy through PV component, then it is converted to the sine AC current which has the same frequency and phase position with the public grid via solar grid-tied inverter, and feedback such energy to the grid.



- It is recommended that the PV array to be installed conforms to IEC 61730 class A standards.

#### 2.1.1 Supported grid connection structure

iMars series grid-tied solar inverters support TN-S, TN-C, TN-C-S, TT and IT grid connection. When applied to the TT connection, the N-to-PE voltage should be less than 30V.

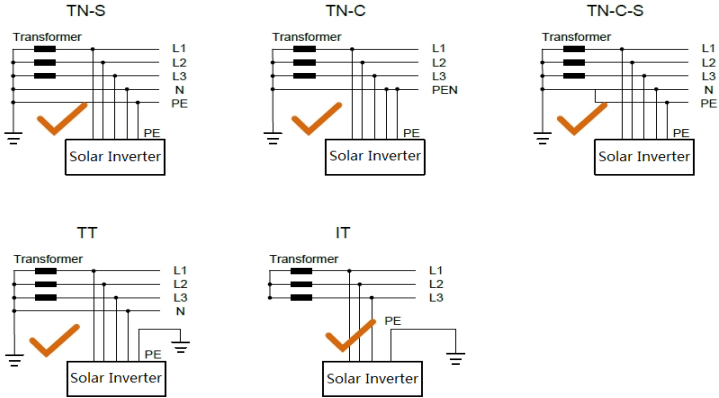

Fig 2.2 Type of grid

## 2.2 Product appearance

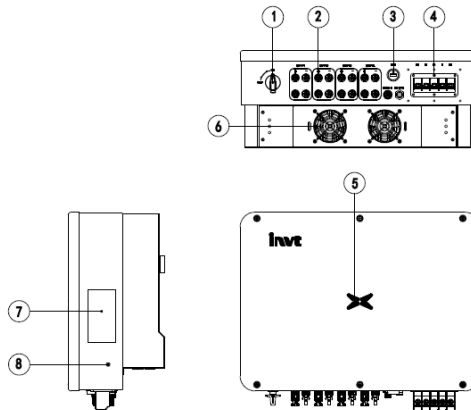

Fig 2.3 Appearance of the three-phase PV inverter

Table 2-1 Instruction list

| No | Name                     | Instructions                                |
|----|--------------------------|---|
| 1  | DC switch                | Switch on or off DC input                   |
| 2  | DC input connectors      | DC input port, connect to PV array          |
| 3  | Communication interfaces | USB, RS485, DRM                             |
| 4  | AC connector             | AC output port, connect to power grid       |
| 5  | LED indicator            | Indicates the working state of the inverter |
| 6  | Fan                      | Air inlet                                   |
| 7  | Nameplate                | Indicates the rated parameters              |
| 8  | Earthing terminal        | Two, connect at least one of them           |

## 2.3 Nameplate

Figure 2.4 shows the inverter nameplate.







|  |                 |                             |     |
|--|-----------------|-----------------------------|-----|
| <b>invt</b>  |                 | Grid-tied<br>Solar Inverter | } 1 |
| <b>iMars XG40KTR</b>   |                 |                             |     |
| DC Input   |                 |                             |     |
| Vmax. PV   | 1100V           |                             |     |
| MPPT Range   | 200V-1000V      |                             |     |
| Max. Current   | 26A/26A/26A/26A |                             |     |
| Isc PV   | 32A/32A/32A/32A |                             |     |
| AC Output  |                 |                             |     |
| Nominal Voltage  | 3/N/PE,230/400V |                             |     |
| Max. Current   | 64.3A           |                             |     |
| Rated Power  | 40000W          |                             |     |
| Frequency  | 50Hz/60Hz       |                             |     |
| Power factor range   | 0.80un ~ 0.80ov |                             |     |
| Environment  |                 |                             |     |
| Temperature  | -30°C ~ +60°C   |                             |     |
| Protective Class   | I               |                             |     |
| Inverter topology  | Non-isolated    |                             |     |
| Ingress protection   | IP66            |                             |     |
|   |                 |                             | } 2 |
|  |                 |                             |     |
| Made in China  |                 |                             |     |
| <b>INVT Solar Technology (Shenzhen) Co., Ltd.</b>                                  |                 |                             | } 3 |

Fig 2.4 Inverter nameplate

- (1) Trademark and product type
- (2) Model and important technical parameters
- (3) Certification systems which the inverter conforms, serial number, company name and country of origin

| Icons   | Instruction   |
|---|---|
|  | <ul style="list-style-type: none"> <li>● TUV certification mark. The inverter is certified by TUV.</li> </ul>           |
|  | <ul style="list-style-type: none"> <li>● CE certification mark. The inverter complies with the CE directive.</li> </ul> |
|  | <ul style="list-style-type: none"> <li>● CQC certification mark. The inverter passed CQC certification.</li> </ul>      |
|  | <ul style="list-style-type: none"> <li>● EU WEEE mark. The inverter cannot be disposed of as domestic waste.</li> </ul> |

## 2.4 Product model

Table 2-2 Models of three-phase grid-tied PV inverter

| Product name                           | Model      | Rated output power(W) |
|--|------------|-----------------------|
| <b>three-phase (L1, L2, L3, N, PE)</b> |            |                       |
| three-phase grid-tied solar inverter   | XG25KTR-3M | 25                    |
| three-phase grid-tied solar inverter   | XG30KTR    | 30                    |
| three-phase grid-tied solar inverter   | XG33KTR    | 33                    |
| three-phase grid-tied solar inverter   | XG36KTR    | 36                    |
| three-phase grid-tied solar inverter   | XG40KTR    | 40                    |
| three-phase grid-tied solar inverter   | XG25KTR-3S | 25                    |
| three-phase grid-tied solar inverter   | XG30KTR-S  | 30                    |
| three-phase grid-tied solar inverter   | XG33KTR-S  | 33                    |
| three-phase grid-tied solar inverter   | XG36KTR-S  | 36                    |
| three-phase grid-tied solar inverter   | XG40KTR-S  | 40                    |

**Note: Refer to the Appendix for technical parameters.**

## 2.5 Outline dimension and weight

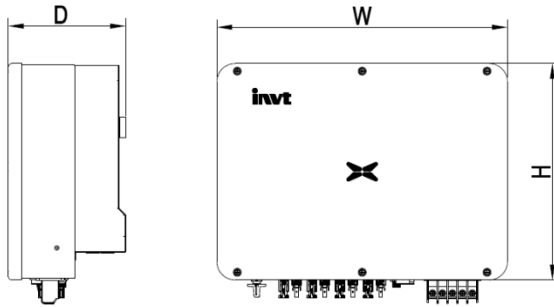

Fig 2.5 Dimensions of the inverter

Table 2-3 Dimensions and weight

| Model   | Height (mm) | Width (mm) | Depth (mm) | Net weight (kg) |
|---------|-------------|------------|------------|-----------------|
| 25-40kW | 425         | 570        | 230        | 37.5            |

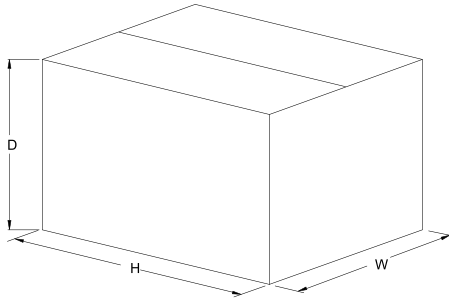

Fig 2.6 Dimension of carton box

Table 2-4 Package dimension and gross weight

| Model   | Height (mm) | Width (mm) | Depth (mm) | Weight (kg) | Package material |
|---------|-------------|------------|------------|-------------|------------------|
| 25-33kW | 680         | 550        | 350        | 40          | carton box       |
| 36-40kW | 680         | 550        | 350        | 42          | carton box       |



## 2.6 The front panel

The front panel comes with LED indicators (modern design) or LCD panel a to indicate the working state of the inverter.

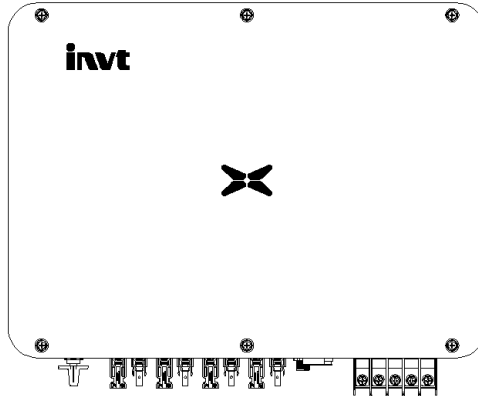
### 2.6.1 LED panel (Modern design)



LED indication:

|   |   |   |
|---|---|---|
|    | Steady green                            | Normal, grid-tied and generating power                                    |
|   | Blinking green at short interval (0.2s) | Bluetooth connected and communicating and inverter has no error           |
|   | Blinking green at long interval (2s)    | DC or AC connected, inverter in standby or starting (no power generation) |
|  | Steady red                              | Error occurs.( The inverter cannot be connected to the grid)              |
|   | Blinking red                            | Bluetooth connected and communicating but inverter has error              |
|   | Off                                     | DC and AC are disconnected  |

### 2.6.2 LCD panel

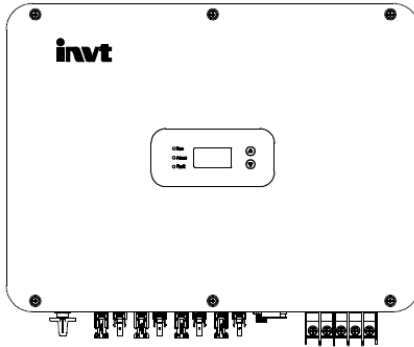

#### LED indicators and buttons:

|   |  |
|---|--|
| ① Run indicator, green, indicates running state;  |  |
| ② Alarm indicator, yellow, indicates alarm state; |  |
| ③ Fault indicator, red, indicates fault state;    |  |
| ④ UP button, for up selection;                    |  |
| ⑤ DOWN button, for down selection.                |  |

### 2.7 Bottom of chassis

XG25-40KTR is equipped with one DC switch, which connects or disconnects all PV inputs.

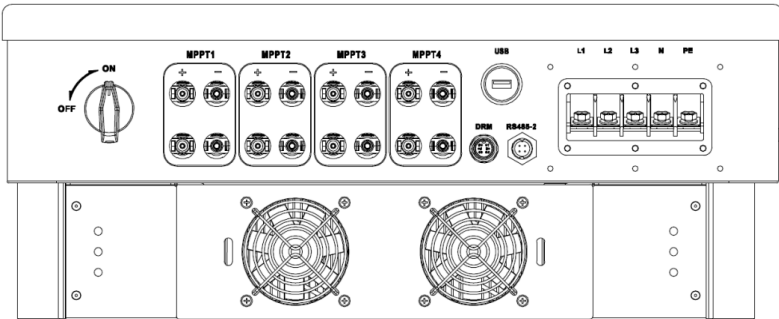

XG25-40KTR bottom view

### 3 Storage

If the inverter is not put into use immediately, the storage of inverter should meet the following requirements:

- Do not remove the outer packing.
- The inverter needs to be stored in a clean and dry place, and prevent the erosion of dust and water vapor.
- The storage temperature should be kept at  $-40^{\circ}\text{C}\sim+70^{\circ}\text{C}$ , and the relative humidity should be kept at 5%RH~95%RH.
- The stacking of inverters is recommended to be placed according to the number of stacking layers in the original shipment. Place the inverter carefully during stacking to avoid personal injury or equipment damage caused by the falling of equipment.
- Keep away from chemically corrosive substances that may corrode the inverter.
- Periodic inspections are required. If damages are made by worms and rats, or packaging is found to be damaged, the packaging materials must be replaced in time.
- After long-term storage, inverters need to be inspected and tested by qualified personnel before put into use.



## 4 Installation

This chapter describes how to install the inverter and connect it to the grid-tied solar system (including the connection between solar modules, public grid and inverter).

Read this chapter carefully and ensure all installation requirements are met before installation. Only qualified electricians are allowed to install the inverter.

### 4.1 Unpacking confirmation

The inverter has been thoroughly tested and rigorously checked before delivery, but damage may still occur during transportation. Before unpacking, check carefully whether the product information in the order is consistent with that on the nameplate of the package box and whether the product package is intact. If any damage is detected, please contact the shipping company or the supplier directly. Please also provide photos of the damage to get our fastest and best service.

Store the idled inverter in its original package and take anti-moisture and anti-dust measures.

After taking the inverter out of the box, check the following items:

Confirm the main body of the inverter is intact and free from any damage;

Confirm there is operation manual, interface accessories and installation accessories inside the package box;

Confirm the deliverables inside the package box are intact and complete;

Check whether the product information in the order is consistent with that on the inverter nameplate;

The standard delivery list is shown below.

Standard deliverables of three-phase inverter:

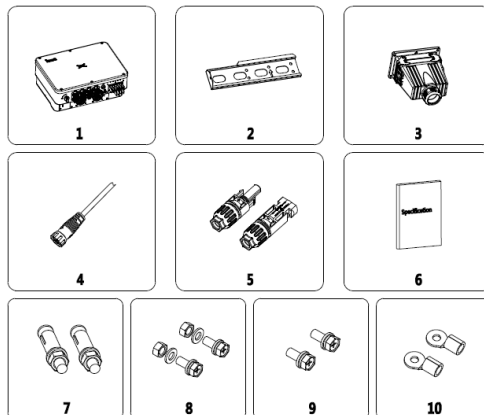

Fig 4.1 Deliverables of XG25-40KTR three-phase inverter

Table 4-1 Deliverables of three-phase inverter

| No | Name                            | Qty  |
|----|---------------------------------|------|
| 1  | Inverter                        | 1    |
| 2  | Installation bracket            | 1    |
| 3  | Water-proof cover for AC output | 1    |
| 4  | RS-485 communication cable      | 1    |
| 5  | DC connector (pair)             | 6/8* |
| 6  | Operation manual                | 1    |
| 7  | Expansion bolt (M8*60)          | 5    |
| 8  | Nuts and bolts (M8)             | 5    |
| 9  | Bolts (M4)                      | 1    |
| 10 | AC ring connector               | 5    |

\*XG25KTR/XG30KTR/XG33KTR 6 pairs

\* XG36KTR/XG40KTR 8 pair

Check above items carefully and if any question, contact the supplier immediately.

## 4.2 Preparation before installation

### 4.2.1 Installation tool

Table 4-2 List of installation tool

| No | Installation tool                     | Purpose  |
|----|---------------------------------------|--|
| 1  | Marker pen                            | Mark the installation hole                                     |
| 2  | Electric drill                        | Drill holes on bracket or the wall                             |
| 3  | Hammer                                | Knock on the expansion bolt                                    |
| 4  | Adjustable wrench                     | Fix the installation bracket                                   |
| 5  | Inner hex screwdriver                 | Tighten the tamper-proof screw and disassemble AC junction box |
| 6  | "Slotted" or "cross-head" screwdriver | AC wiring  |
| 7  | Megaohmmeter                          | Measure the insulation and grounding impedance                 |
| 8  | Multimeter                            | Check the circuit and measure AC/DC voltage                    |
| 9  | Electric soldering iron               | Solder the communication cable                                 |
| 10 | Wire crimper                          | Crimp DC terminal  |
| 11 | Hydraulic clamp                       | Crimp ring connector for AC wiring                             |

#### 4.2.2 Installation environment

- (1) The inverter can be installed in indoor and outdoor environment.
- (2) During the operation of the inverter, the temperature of the chassis and heat sink will be relatively high. Please do not install the inverter in the easily touched position.
- (3) Do not install inverters in areas where flammable and explosive materials are stored.
- (4) The inverter shall be installed in a place which has good ventilation to ensure good heat dissipation.
- (5) It is recommended to choose the installation site with shelter or build sunshade.

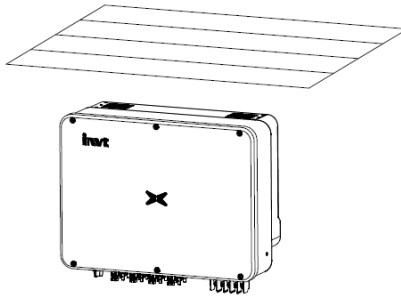

Fig 4.2 sunshade

- (6) The installation environment temperature is  $-25\text{ }^{\circ}\text{C} \sim 60\text{ }^{\circ}\text{C}$ ;
- (7) The installation site should be far away from the electronic equipment with strong electromagnetic interference;
- (8) The installation site should be fixed and solid object surface, such as wall, metal support, etc;
- (9) The installation position shall ensure the reliable grounding of the inverter, and the grounding metal conductor material shall be consistent with the reserved grounding metal material of the inverter.

### 4.3 Space requirements

- (1) Recommend to install the inverter to the height of eye level to check the inverter state conveniently.

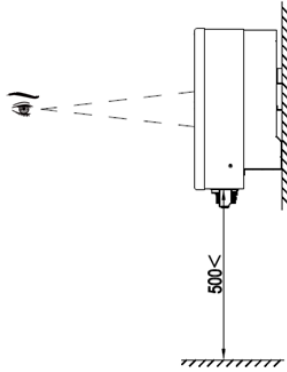

Fig 4.3 optimal installation height

- (2) Make sure there is enough space for installation and ventilation, see below recommendations.

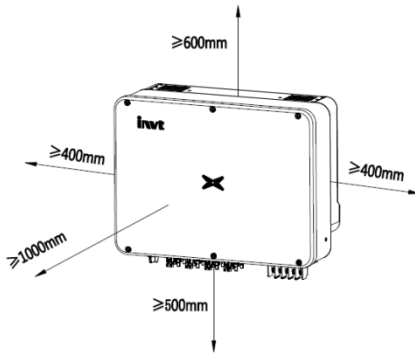

Fig 4.4 installation spacing of inverter

- (3) When installing multiple inverters, a certain distance should be reserved between the inverters, as shown in Figure 4.4. At the same time, sufficient distance should be reserved between the upper and lower parts of the inverter to ensure good heat dissipation.

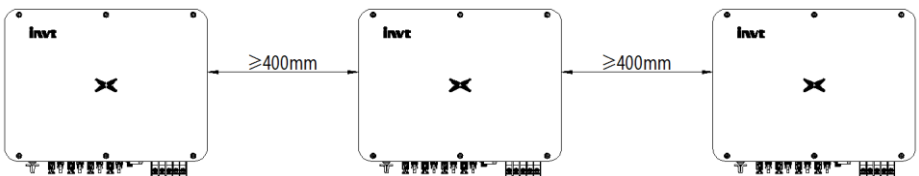

Fig 4.5 side by side installation spacing requirements

- (4) Install the inverter vertically or lay back a little bit ( $\leq 15^\circ$ ) for good heat dissipation. Do not tilt the inverter forward, horizontally, upside down, over-backward or roll it.

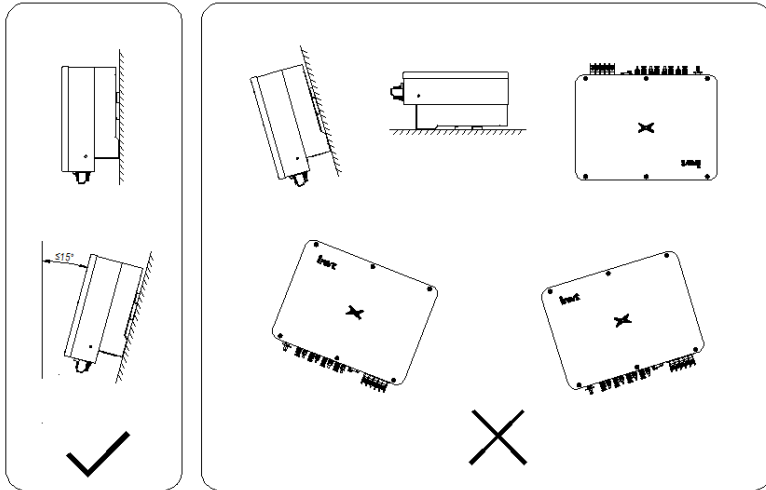

Fig 4.6 installation posture of inverter

#### 4.4 Dimensions of the mounting bracket

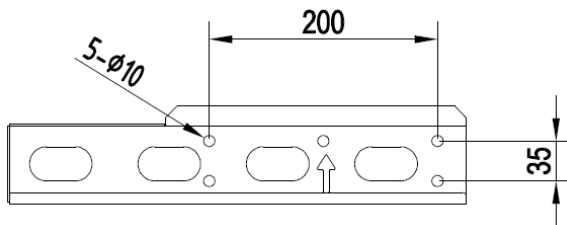
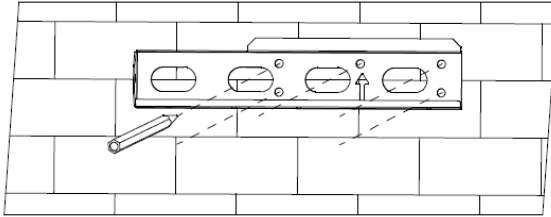

Fig 4.6 dimensions of mounting bracket

## 4.5 Wall installation

**Step 1:** Put the brackets onto the wall and adjust the horizontal level using the level meter, mark the bolt positions with marker pen.



**Step 2:** Drill holes on the wall for the M8 x 60 expansion bolts with impact drill.

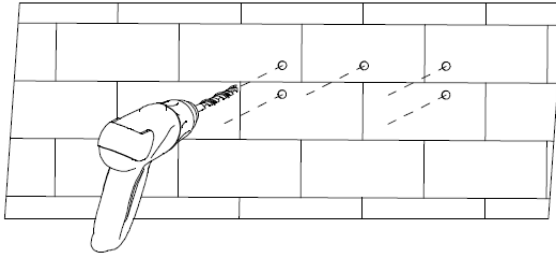

**Step 3:** Clean the dust out from the holes and knock the screw and expansion tube of the expansion bolts into the holes with a rubber hammer. Put the bracket, flat pads, spring pads and nuts in turn onto the bolts. Tighten the nuts with 13N•m.

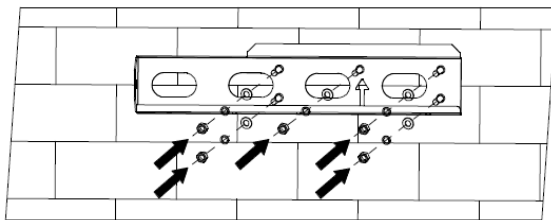

## 4.6 Installation of inverter

**Step 1:** Take the inverter out of the packing box.

**Step 2:** If the installation position is high, it is necessary to lifting machine to lift the inverter. Lift the inverter 100 mm up from the ground and pause, double check if everything is tight and the lifting is safe.

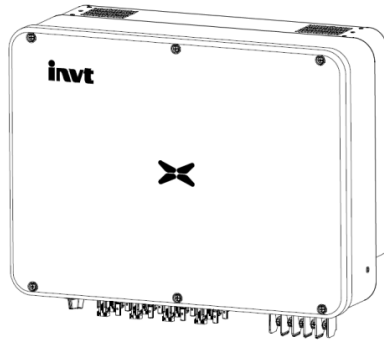

**Step 3:** Hang the inverter onto the bracket and make sure the hanging is in place.

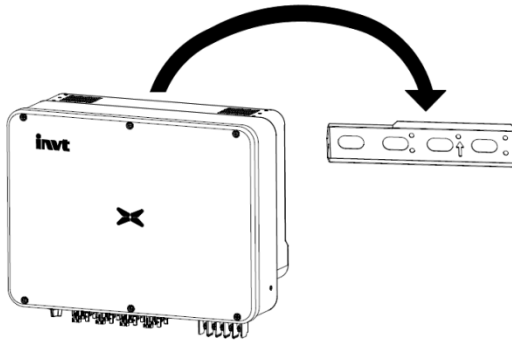

**Step 4:** Fix the inverter and the bracket with one M4 x 12 screw on the left side of the inverter with 2.5N•m, see below.

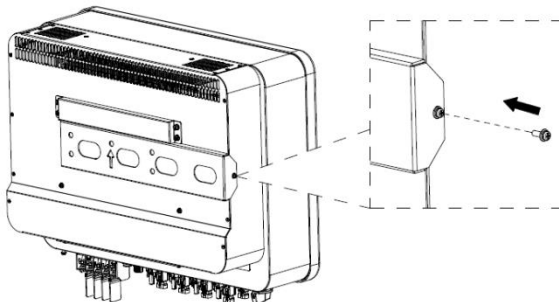

## 5 Electrical connection

### 5.1 Overview of electrical connection

This section presents the detailed contents and safety precautions related to electrical connection.

Fig 5.1 is the connection diagram for Grid-tied PV system.

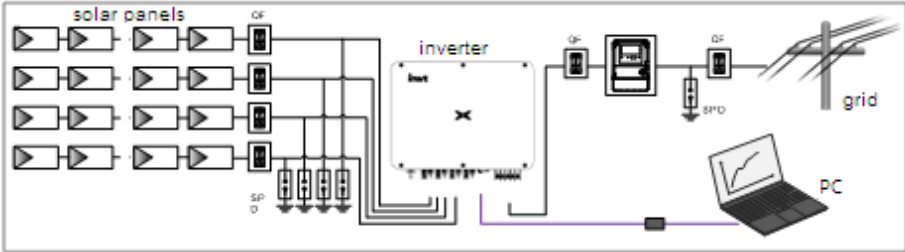



Fig 5.1 Connection diagram of the Grid-tied PV system

|   |  |
|---|--|
|  | <ul style="list-style-type: none"> <li>● Electrical connection must be carried out by professional technicians as wrong operation may cause damage to the device, physical injuries or even death during system operation.</li> <li>● All the electrical installation must conform with the national regulations concerning electrical safety regulations.</li> <li>● Ensure all the cables are installed firmly according to the specified safety requirements and free from any damage.</li> <li>● It is not allowed to close the AC and DC breakers before all cable connections are finished.</li> </ul> |
| <p><b>Note</b></p>  | <ul style="list-style-type: none"> <li>● Read this section carefully and operate strictly according to the requirements.</li> <li>● Note the rated voltage and current specified in the manual as they cannot be exceeded.</li> </ul>  |

### 5.2 Connect the protective earth wire

**Step 1:** Crimp OT terminal on the ground wire.

**Step 2:** Fix the ground wire on the side of right side of the inverter with 4-5 N·m, see below



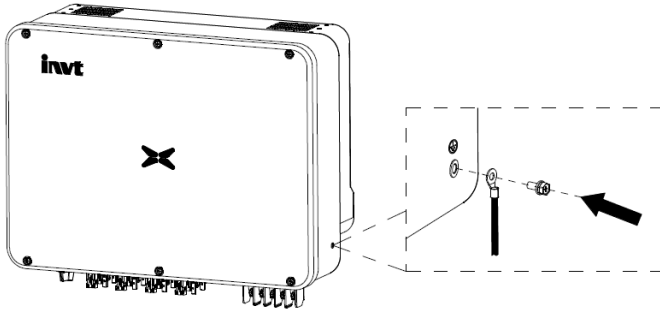

### 5.3 Connection of solar string

**Step 1:** Make MC4 connectors for each PV string

MC4 crimping method:

(1) Remove 8-10mm cable sheath from the PV cable (see A and B below), crimp the inner contact of MC4 connector with (see C below, the longer one is for positive PV wire);

Take off the nuts of the MC4 and insert the crimped cables through the nuts (see D and E below, the D is for the positive wire);

Tighten the nuts with 2.5-3 N·m (see F below)

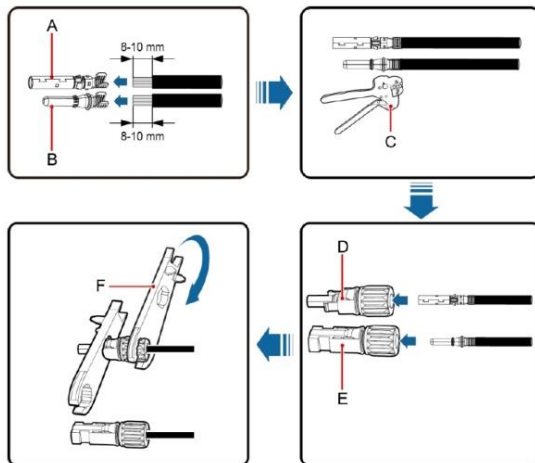

Fig 5.2 MC4 connector making

(2) Verify the polarity of the MC4 connector, make sure they are correct (see Fig 5.3). Check if the voltage of the PV string is within what's expected. Make sure to check each PV string.

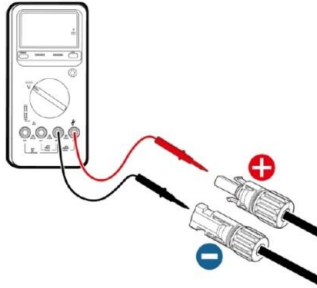



Fig 5.3 DC input polarity and voltage check

|   |   |
|---|---|
|  | <ul style="list-style-type: none"> <li>● Use the DC connectors delivered along with the inverter, do not use other connectors without authorization from our company, otherwise damage to the device, unstable operation or fire may occur and our company will not undertake quality assurance or assume any direct or joint liability thereof.</li> </ul> |
|---|---|

**Step 2:** Connect the MC4 connectors to the inverter, Make sure to distinguish each pair of PV string.

- (1) Connect the MC4 connectors to the inverter, you will hear the 'click' sound;
- (2) To disconnect the MC4 connection, use MC4 spanner as below and unplug;

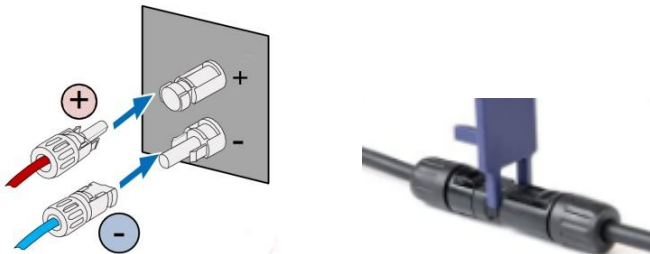



Fig 5.4 Connect and disconnect PV string connection

## 5.4 Three-phase inverter grid connection

Table 5-1 Interface description of three phase solar inverter AC connector

| Inverter AC connector interface   | Three phase grid | remarks           |
|---|------------------|-------------------|
| L1  | L1 (A)           |                   |
| L2  | L2 (B)           |                   |
| L3  | L3 (C)           |                   |
| N   | N(Neutral line)  |                   |
|  | PE (ground wire) | Must be connected |

### 5.4.1 Grid connection

(1) Crimp ring connectors on the AC cable for the Grid, the N of the five cores (L1, L2, L3, N, PE) is optional. It is very important that the crimping is tight and reliable;

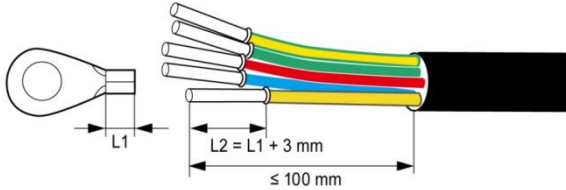

Fig 5.5 crimping cable terminals

(2) Connect the crimped AC cable to the AC block of the inverter with 7-9N•m (PE) and connect the AC water-proof cover.

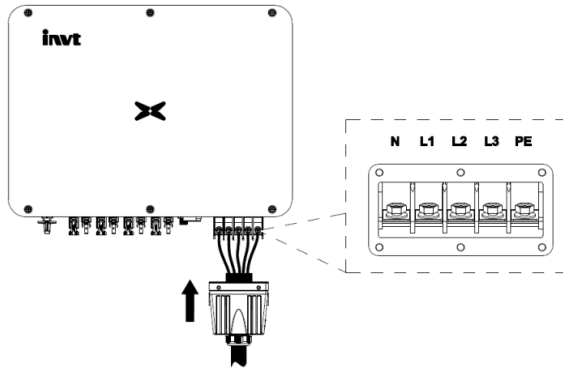

Fig 5.6 AC connection

(3) Lock the AC water-proof cover on the left and right, see below.

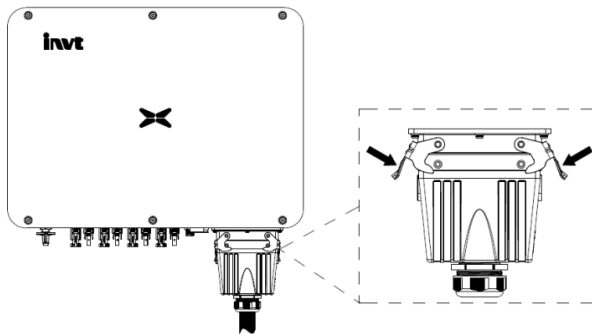
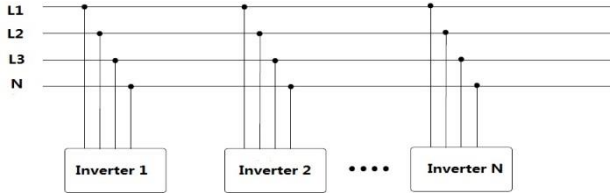

Fig 5.7 AC water-proof cover lock

**5.4.2 Parallel operation requirements**

Multiple inverters can be connected to the low-voltage three-phase grid directly, contact us if the total capacity of the inverters exceeds 0.5-0.8MVA.



If the Grid is not low-voltage, a step-up transformer should be used. Connect the inverters to the low voltage side of transformer. The transformer used should have capacity higher than the total capacity of the inverters. The transformer should have neutral point.

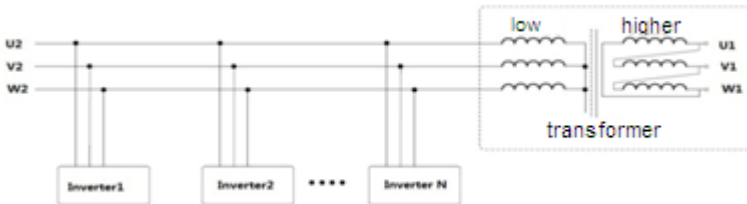

|   |   |
|---|---|
|  | <ul style="list-style-type: none"> <li>● It is recommended to use the transformer whose short-circuit impedance is no more than 7%</li> </ul> |
|---|---|

## 6 Running

This chapter mainly introduces inverter operations related to inspection before running, power generation, stop power generation and maintenance.

### 6.1 Inspection before running

The following items must be checked strictly before running the Grid-tied PV inverter (including but not limited to the following items):

- (1) Confirm the installation site of the inverter fulfill requirements of section 4.2.2 to ensure convenient installation, disassemble, operation and inspection on the inverter;
- (2) Confirm the mechanical installation of the inverter fulfills requirements of section 4.3;
- (3) Confirm the electrical connection of the inverter fulfills the requirements of section 4.4;
- (4) Confirm all the switches are in "OFF" state;
- (5) Confirm the open-circuit voltage of each PV string conforms to the parameter requirements of inverter DC ratings, the ratings can be check in the Appendix;
- (6) Confirm the electrical safety marks on the installation site is clear enough.



- In order to ensure a safe, normal and stable operation of the PV power generation system, all the newly installed, renovated and repaired Grid-tied PV power generation system and its grid-tied inverter must undergo inspection before running.

### 6.2 Inverter grid-tied running

Start the inverter according to below steps to achieve grid-tied operation of the inverter:

#### Note

- The Grid standard must be set for the initial setup, set the Grid standard according to the your national standard
- Keep the inverter power on for at least 30 minutes to charge the built-in clock battery of the inverter to ensure the clock can run normally!

- (1) Confirm the requirements in section 6.1 are fulfilled;
- (2) Close the AC breaker to connect the inverter to the Grid;
- (3) Close the built-in DC switch of the inverter;
- (4) Close the external DC switch to connect the PV strings to the inverter;
- (5) Observe the LED indicator state of the inverter (For details, please see 2.6.1 and 2.6.2 LED indications)

-  Run Green running LED blinks (the other two LEDs are off): Inverter powered on and self-checking, waiting for enough solar power for generation;

- Run Running LED is solid green (the other two LEDs are off): Inverter self-checking passed, generation power to the Grid.

'Alarm' or 'Fault' is on or blinks: Inverter powered on but has errors. Check on the LCD and look up the codes on Table 8-1 for the definition of the codes. To troubleshoot, stop the inverter first (refer to section 6.3) and refer to section 8 for troubleshooting. Upon all faults are cleared, refer to section 5 to connecting the inverter back to the system.

## 6.3 Inverter stop

When it is necessary to carry out power-off maintenance, inspection and fault elimination on the inverter, stop the inverter according to the following steps:

- (1) Disconnect the AC breaker to disconnect the Grid from the inverter;
- (2) Disconnect the built-in DC switch of the inverter;
- (3) Disconnect the external DC breaker to disconnect PV strings;
- (4) Before trying to take off or open the inverter, wait for at least 5 minutes until the internal parts of the inverter are fully discharged.

## 6.4 Regular inspection and maintenance

The inverter can run in all seasons, it starts and stops power generation automatically, but to ensure system stability and extend inverter life span, it is necessary to perform regular inspection and maintenance according to the manual.

### 6.4.1 Regular inspection and maintenance list

| Inspection item        | Inspection method   | Maintenance cycle    |
|------------------------|---|----------------------|
| Inverter running data  | Backup the running data, parameters and logs on the monitoring software.  | Once per quarter     |
| Inverter running state | Check if the inverter is hung reliably, has visible dent or deformed. Check if there is abnormal running noise in the inverter. Check if running data makes sense. Check if the housing is too hot with thermal camera. | Once per half a year |
| Clean the inverter     | Check the ambient humidity and dust, refer to section 6.4.2 to clean the inverter when necessary.   | Once per half a year |
| Electrical connection  | Check if the electrical connection is loose, refer to corresponding section to tighten the connection if necessary. Check if the cable sheath has visible damage, especially where it is close to the metal.            | Once per half a year |
| Cooling fan            | Check if the air intake and exhaust are normal, check if the fan has abnormal running noise and if its blades have  | Once per half a year |

| Inspection item | Inspection method   | Maintenance cycle    |
|-----------------|---|----------------------|
|                 | cracks. Clean the air inlet if necessary. Refer to corresponding section to change the fan if necessary.  |                      |
| Safety function | Stop power generation on the LCD to verify the function, check the communication under such condition. Check if the warning sign is complete and clear, change it if necessary. | Once per half a year |

#### 6.4.2 Maintenance guidance

##### Clean the inverter

The cleaning steps are listed below:

- (1) Disconnect the AC and DC connection;
- (2) Wait for ten minutes;
- (3) Clean the surface and air inlet/outlet of the inverter with soft brush or vacuum cleaner;
- (4) Repeat the operations in section 6.1;
- (5) Restart the inverter.

##### Fan maintenance

|   |   |
|---|---|
|  | <ul style="list-style-type: none"> <li>● Disconnect AC and DC connections of the inverter to stop the inverter before maintenance.</li> <li>● After AC and DC are disconnected, wait for at least 10 minutes until the internal capacitors of the inverter are fully discharged before maintenance.</li> <li>● The fan can be maintained and replaced by professional electricians only.</li> </ul> |
|---|---|

**Step 1:** Stop the inverter and disconnect the electrical connections.

- (1) Disconnect the DC input and AC output circuit breakers.
- (2) Turn the built-in DC switch to the "OFF" position.
- (3) Wait at least 10 minutes.
- (4) Disconnect all cable connections from the bottom of the inverter.

**Step 2:** Unscrew the screws as below, unplug the fan cables and remove the fan plate at the bottom.

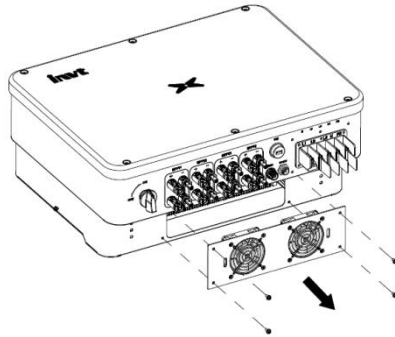

**Step 3:** Clean the fan with dusting brush or vacuum cleaner, change it if the fan has been damaged (refer to below Step 4).

**Step 4:** If the fan has been damaged, refer to below picture to change it with a new one.

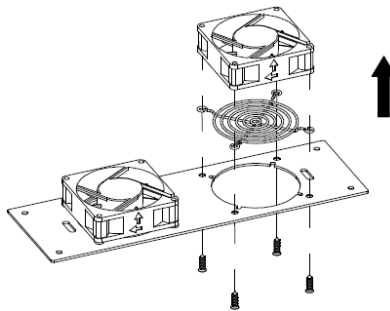

**Step 5:** Install the fan plate back to the bottom of the inverter and connect all the cables back and make sure all connections are tight and reliable, restart the inverter.

**Note**

- Once the inverter stops due to an alarm, it is forbidden to start the machine immediately. The cause should be identified and all faults must be eliminated before starting up. Inspections should be carried out in strict accordance with the procedures in Section 6.1



## **7 LCD display operation**

This chapter describes the LCD operation and LED indicators.

## 8 Troubleshooting

This chapter describes the error codes for fast troubleshooting.

Table 8-1 Inverter error codes

| Code     | Descriptions (short) | Descriptions (long)             | Troubleshooting tips   |
|----------|----------------------|---------------------------------|--|
| <b>A</b> |                      |                                 |  |
| A001     | Input UV             | Input under-voltage             | PV under-voltage   |
| A002     | Bus UV               | Bus under-voltage               | PV under-voltage or boost circuit fail   |
| A003     | Grid UV              | Grid under-voltage              | Grid voltage is too low  |
| A004     | Grid OV              | Grid over-voltage               | Grid voltage is too high   |
| A005     | Grid UF              | Grid under-frequency            | Grid frequency is too low  |
| A006     | Grid OF              | Grid over-frequency             | Grid frequency is too high   |
| A007     | Clock Fail           | Clock fail                      | Wrong time set on the clock  |
| A009     | Cmd Shut             | Manual off                      | Inverter has been manually turn off (via handheld HMI or supervisory computer)                       |
| A011     | Grid Loss            | Grid lost                       | Check if the AC is connected (e.g., check if AC breaker is connected) or the Grid has normal voltage |
| <b>E</b> |                      |                                 |  |
| E001     | Input OV             | Input over-voltage              | PV input voltage is too high   |
| E003     | Bus OV               | Bus over-voltage                | Inverter internal bus voltage is too high  |
| E004     | Boost Fail           | Boost fail                      | Inverter boost circuit fail  |
| E005     | Grid OC              | Grid over-current               | Inverter AC output current is too high   |
| E006     | OTP                  | Over temperature protection     | Inverter internal temperature is too high  |
| E007     | Riso Low             | Isolation resistance is too low | Isolation resistance is too low  |
| E008     | IGBT drv             | IGBT driver protected           | Inverter IGBT driver protection is triggered   |
| E009     | IntComm              | Internal communication error    | The internal main and aux DSPs cannot communicate with each other or the data check failed           |
| E010     | ILeak Fail           | Leakage current is too high     | System/inverter leakage current is too high  |

| <b>Code</b> | <b>Descriptions (short)</b> | <b>Descriptions (long)</b> | <b>Troubleshooting tips</b>                                   |
|-------------|-----------------------------|----------------------------|---|
| E011        | Relay Fault                 | Relay fault                | Inverter internal relay has fault                             |
| E012        | Fan Fail                    | Fan fail                   | Inverter fan has fault  |
| E013        | Eeprom                      | Memory abnormal            | Inverter internal memory has fault                            |
| E014        | Dc inject                   | DC component is too much   | DC component is too much in the AC output                     |
| E015        | OutputShort                 | Output short circuit       | AC output short circuit                                       |
| E018        | Input OC                    | Input over-current         | Input over-current  |
| E019        | Incnst                      | Data inconsistent          | The sample data is inconsistent between the main and aux DSPs |
| E020        | PowerReversed               | DC power reversed          | DC power reversed   |

If any problem, please contact with the supplier and provide following information:

- Model of the inverter: \_\_\_\_\_;
- Serial No. of the inverter: \_\_\_\_\_;
- System version:  
——version 1: \_\_\_\_\_;  
——version 2: \_\_\_\_\_;
- MCU software version: \_\_\_\_\_;
- Fault code: \_\_\_\_\_;
- Fault description \_\_\_\_\_

## 9 Contact us

### China·Shenzhen

INVT Solar Technology (Shenzhen) Co., Ltd.

Address: 6th Floor, Block A, INVT Guangming Technology Building, Songbai Road, Matian,  
Guangming District, Shenzhen, China

Service hotline: +86 400 700 999

E-mail: [solar-service@invt.com.cn](mailto:solar-service@invt.com.cn)

INVT group website: [www.invt.com](http://www.invt.com)

INVT solar website: [www.invt-solar.com](http://www.invt-solar.com)

## 10 Appendix

Table 9-1 Datasheet

| Model         |  | XG25KTR-3M  | XG30KTR  | XG33KTR  | XG36KTR  | XG40KTR  |
|---------------|--|---|----------|----------|----------|----------|
| DC            | Max. DC voltage (V)  | 1100  | 1100     | 1100     | 1100     | 1100     |
|               | Start-up voltage (V)   | 250   | 250      | 250      | 250      | 250      |
|               | MPPT voltage range (V)   | 200~1000  | 200~1000 | 200~1000 | 200~1000 | 200~1000 |
|               | DC voltage range during rated output power (V)   | 450-800V  | 500-800V | 500-800V | 500-800V | 500-800V |
|               | MPPT number/<br>PV string number per MPPT  | 3/2   | 3/2      | 3/2      | 4/2      | 4/2      |
|               | Max. PV array power (W)  | 40000   | 48000    | 52800    | 57600    | 64000    |
|               | Max. input current each MPPT (A) x MPPT number   | 26x3  | 26x3     | 26x3     | 26x4     | 26x4     |
|               | Max. Isc (short-circuit current) of the PV array within each MPPT (A)  | 32  | 32       | 32       | 32       | 32       |
| AC            | Rated output power (W)   | 25000   | 30000    | 33000    | 36000    | 40000    |
|               | Rated voltage and frequency range (V)  | 230/400Vac,3L+N+PE/3L+PE,50/60Hz±5HZ (adjustable)                             |          |          |          |          |
|               | Rated AC output current (A)  | 36.2  | 43.5     | 47.8     | 52.2     | 57.9     |
|               | Max. AC output current (A)   | 40.1  | 48.3     | 53       | 57.8     | 64.3     |
|               | Power factor   | -0.8~+0.8 (adjustable)  |          |          |          |          |
|               | THDi   | < 3% (@Rated power)   |          |          |          |          |
| System        | Cooling method   | Smart fan   |          |          |          |          |
|               | Max. efficiency  | 98.60%  |          |          |          |          |
|               | European efficiency  | 98.20%  |          |          |          |          |
|               | MPPT efficiency  | 99.90%  |          |          |          |          |
|               | Ingress protection   | IP66  |          |          |          |          |
|               | Power consumption at night   | < 1W  |          |          |          |          |
|               | Protective class   | I   |          |          |          |          |
|               | Overvoltage protection class   | AC:III,PV:II  |          |          |          |          |
|               | Inverter topology  | Non-isolated  |          |          |          |          |
|               | Pollution degree   | 3   |          |          |          |          |
|               | Operating temperature  | (-25℃~+60℃), auto derating is required if the ambient temperature exceeds 45℃ |          |          |          |          |
|               | Humidity   | RH 0~100%,condensation  |          |          |          |          |
|               | Max. altitude (m)  | ≤4000, derating is required if the altitude exceeds 3000m                     |          |          |          |          |
|               | Display  | LED, Bluetooth + APP  |          |          |          |          |
|               | System language  | English, Chinese, Germany, Dutch  |          |          |          |          |
| Communication | RS485 (standard) /WiFi (optional) /4G (optional) /GPRS (optional)  |   |          |          |          |          |
| DC terminal   | MC4 water-proof connector  |   |          |          |          |          |
| Installation  | Wall mount   |   |          |          |          |          |
| Protections   | Input overvoltage protection, input overcurrent protection, DC insulation monitoring, DC monitoring, grounding fault current monitoring, grid monitoring, islanding protection, short-circuit protection and overheat protection, etc. |   |          |          |          |          |

Table 9-2 Datasheet

| Model        |  | XG25KTR-3S  | XG30KTR-S | XG33KTR-S | XG36KTR-S | XG40KTR-S |
|--------------|--|---|-----------|-----------|-----------|-----------|
| DC           | Max. DC voltage (V)  | 1100  | 1100      | 1100      | 1100      | 1100      |
|              | Start-up voltage (V)   | 250   | 250       | 250       | 250       | 250       |
|              | MPPT voltage range (V)   | 200~1000  | 200~1000  | 200~1000  | 200~1000  | 200~1000  |
|              | DC voltage range during rated output power (V)   | 500-800V  | 500-800V  | 500-800V  | 500-800V  | 500-800V  |
|              | MPPT number/<br>PV string number per MPPT  | 3/1   | 3/1       | 3/1       | 4/1       | 4/1       |
|              | Max. PV array power (W)  | 48000   | 52800     | 57600     | 64000     | 64000     |
|              | Max. input current each<br>MPPT (A) x MPPT number  | 16x3  | 16x3      | 16x3      | 16x4      | 16x4      |
|              | Max. Isc (short-circuit<br>current) of the PV array<br>within each MPPT (A)  | 20  | 20        | 20        | 20        | 20        |
| AC           | Rated output power (W)   | 25000   | 30000     | 33000     | 36000     | 40000     |
|              | Rated voltage and<br>frequency range (V)   | 230/400Vac,3L+N+PE/3L+PE,50/60Hz±5HZ (adjustable)                             |           |           |           |           |
|              | Rated AC output current (A)  | 36.2  | 43.5      | 47.8      | 52.2      | 57.9      |
|              | Max. AC output current (A)   | 40.1  | 48.3      | 53        | 57.8      | 64.3      |
|              | Power factor   | -0.8~+0.8 (adjustable)  |           |           |           |           |
|              | THDi   | 230/400Vac,3L+N+PE/3L+PE,50/60Hz±5HZ (adjustable)                             |           |           |           |           |
| System       | Cooling method   | Smart fan   |           |           |           |           |
|              | Max. efficiency  | 98.60%  |           |           |           |           |
|              | European efficiency  | 98.20%  |           |           |           |           |
|              | MPPT efficiency  | 99.90%  |           |           |           |           |
|              | Ingress protection   | IP66  |           |           |           |           |
|              | Power consumption at night   | < 1W  |           |           |           |           |
|              | Protective class   | I   |           |           |           |           |
|              | Overvoltage protection class   | AC:III,PV:II  |           |           |           |           |
|              | Inverter topology  | Non-isolated  |           |           |           |           |
|              | Pollution degree   | 3   |           |           |           |           |
|              | Operating temperature  | (-25℃~+60℃), auto derating is required if the ambient temperature exceeds 45℃ |           |           |           |           |
|              | Humidity   | RH 0~100%, condensation   |           |           |           |           |
|              | Max. altitude (m)  | ≤4000. derating is required if the altitude exceeds 3000m                     |           |           |           |           |
|              | Display  | LED, Bluetooth + APP  |           |           |           |           |
|              | System language  | English, Chinese, Germany, Dutch  |           |           |           |           |
|              | Communication  | RS485 (standard) /WiFi (optional) /4G (optional) /GPRS (optional)             |           |           |           |           |
|              | DC terminal  | MC4 water-proof connector   |           |           |           |           |
| Installation | Wall mount   |   |           |           |           |           |
| Protections  | Input overvoltage protection, input overcurrent protection, DC insulation monitoring, DC monitoring, grounding fault current monitoring, grid monitoring, islanding protection, short-circuit protection and overheat protection, etc. |   |           |           |           |           |



Sales E-mail: [solar@invt.com.cn](mailto:solar@invt.com.cn) Service E-mail: [solar-service@invt.com.cn](mailto:solar-service@invt.com.cn) Website: [www.invt-solar.com](http://www.invt-solar.com)



**INVT Solar Technology (Shenzhen) Co., Ltd.**

2th Floor, Block B, INVT Guangming Technology Building, Songbai Road, Matian, Guangming District, Shenzhen, China